



Filters . Accumulators

Low / Medium Pressure Duplex Filter

Inline mounting
Type : 40/160-LD/LDN

Technical Data

Design	: Duplex Inline
Max. Pressure (PS)	: 40 bar [580 psi] 160 bar [2321 psi].
Test Pressure (PT)	: 1.43 x PS (as per CE/PED) 1.3 x PS (as per ASME)
Temperature range	: -20°C to +100°C (Standard) -4°F to +212°F (Standard)
Connection	: Upto SAE 1-1/2" / SAE-32
Element design	: LD Series - EPE standard LDN Series - As per DIN-24550
Material of Construction	
Head	: GGG50.
Bowl	: Carbon Steel.
Seals	: Nitrile / Viton / EPDM.
Paint	: Bowl Externally painted in RAL-5010. Others on request.

Flow Capacity	
0005 / 0040	50 lpm [13 gpm]
0008 / 0063	80 lpm [20 gpm]
0013 / 0100	130 lpm [35 gpm]
0015	150 lpm [40 gpm]
0018	180 lpm [45 gpm]
0020 / 0160	200 lpm [50 gpm]
0030 / 0250	300 lpm [65 gpm]
0045 / 0400	450 lpm [100 gpm]



Hydraulic Symbol

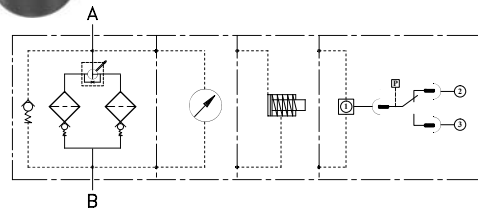

Description

The 40/160-LD/LDN series Filters are used for direct installation in the pipeline and provide wear protection of downstream components & systems. Duplex in design for inline mounting the filter inlet & outlet are located the opposite sides. The flow path arrow (inlet to outlet) is marked on filter head.

The Filter head is provided with two element locating spigots - one in each housing - and a change-over valve with metal to metal sealing and integral pressure equalization valve. The change-over handle points to the housing in operation. The integral pressure equalization is activated when the change-over handle is lifted to effect change over and deactivated once the change-over handle is released at the end position.

The Filter bowls are mounted below the filter head and unscrewed for maintenance.

Accessories

Maintenance indicator - for monitoring the filter element contamination status. Available in various designs including

- Optical (pop-up version) with Electrical option.
- Optical (dual dial version) with Electrical option.
- Optical-Electrical with 2 switching points.

Magnet - to protect the filter from ferrous contamination.

Bypass valve - to protect the filter element during start-up and over pressurisation due to clogging.

Vent valve - for removing the air from the filter during starting and for safe depressurisation.

Drain valve - for draining the filter during servicing.

Filter Element

The Filter Element is of star-pleated design with optimised pleat density for providing prolonged life.

The filter element is of Out-to-In design and the contaminant is retained outside the filter element and collected in the filter bowl.

The elements are available in various media options and selected based on the required oil cleanliness, initial pressure drop and dirt holding capabilities.

- Media options for the filter element include
- SS Wire Mesh - Cleanable, Nominal filtration.
 - Paper - Non-cleanable, Nominal filtration.
 - Non-woven - Non-cleanable, Nominal filtration.
 - Inorganic glass fibre - Non-cleanable, Absolute filtration acc. to ISO-16889.
 - Aquasorb - Water absorbing media, Non-cleanable.

For special applications / fluids the filter elements are supplied with SS hardware (end caps & inner tube) and / or different adhesives.

Technical specifications subject to change.

Ordering Code - Filter

1 2 3 4 5 6ab 7 8 9ab 10 11 12 13
160 - **LD** - **0013** - **H10XP** - **A** - **0 P** - **0** - **9** - **A5.0** - **G06** - **P** - **0** - **0** /

1	Max. working pressure	40 Bar 160 Bar	= 40 = 160
2	Filter type	Duplex Inline - EPE Standard Element Duplex Inline - Element acc. to DIN 24550	= LD = LDN
3	Nominal Size	Filter type LD Filter type LDN	= 0003 (* 2.0004 element) = 0005 0008 0013 0015 0018 0020 0030 0045 = 0040 0063 0100 0160 0250 0400
4	Filtering Media & Filtration Grade	<u>Nominal Filtration Grade</u> SS Wire Mesh Cleanable with additional epoxy layer upstream for 10/25/40µm	= G10 G25 G40 G60 G80 G100 Others on request
		Paper Non-cleanable with epoxy mesh	= P5 P10 P25
		Non-Woven Non-cleanable with epoxy mesh	= VS10 VS25 VS40 VS60
		<u>Absolute Filtration Grade (ISO16889)</u> Glass Fibre Non-cleanable with epoxy mesh	= H1XL H3XL H6XL H10XL H16XL H20XL
		Long Life Glass Fibre Non-cleanable with plastic mesh & outer sleeve	= H3XP H5XP H10XP H15XP H20XP
		Long Life Glass Fibre Non-cleanable with epoxy mesh	= H3XE H5XE H10XE H15XE H20XE
		Glass Fibre - Electrically Conductive Non-cleanable with epoxy mesh	= H3XC H5XC H10XC H15XC H20XC
		Glass Fibre - Water Absorbing Non-cleanable with epoxy mesh	= AS1 AS3 AS6 AS10 AS20
	SS Fibre Cleanable with SS mesh	= M5 M10 M15	
5	Differential Pressure of Element	<u>Maximum allowed differential pressure</u> 30 bar [435 psid] 60 bar [870 psid] 160 bar [2321 psid]	= A (standard) = D = C
6a	Element Adhesive	Standard Adhesive T=100°C [212°F] Epoxy Adhesive (for fuels) High Temp. Adhesive T=160°C [320°F]	= 0 (standard) = 1 = E
6b	Element Hardware (End Caps + Inner Tube)	Carbon Steel + Carbon Steel Polyamide + Carbon Steel Stainless Steel + Stainless Steel Nickel Coated CS + Nickel Coated CS Carbon Steel + Stainless Steel	= C = P (standard) = X = D = M
7	Magnet	Without With ring magnet ^(a)	= 0 (standard) = X

* Before ordering, check for availability.

^(a) Magnets kept loose under the elements.

Ordering Code - Filter

1 2 3 4 5 6ab 7 8 9ab 10 11 12 13
160 - LD - 0013 - H10XP - A - 0 P - 0 - 9 - A5.0 - G06 - P - 0 - 0 /

8	Bypass Valve	Without With Bypass Valve - 0.3 bar [4.35 psid] With Bypass Valve - 0.8 bar [11.6 psid] With Bypass Valve - 1.5 bar [21.7 psid] With Bypass Valve - 2.0 bar [29.0 psid] With Bypass Valve - 2.5 bar [36.2 psid] With Bypass Valve - 3.0 bar [43.5 psid] With Bypass Valve - 3.5 bar [50.7 psid] With Bypass Valve - 5.0 bar [72.5 psid] With Bypass Valve - 7.0 bar [101.5 psid] With special setting Bypass valve	= 0 (standard) = 1 = 2 = 3 = 4 = 5 = 6 = 7 (std for 40-LD/LDN) = 8 = 9 (std for 160-LD/LDN) = Bx (x = pressure bar)
9a	Maintenance Indicator - type	Without Optical (Pop-up) Optical(Pop-up) + Electrical with DIN Plug Optical(Pop-up) + Electrical with Lamp Optical + Electrical with 2 Switching points - set to operate at 75% and 100% Optical (Dual dial) Optical(dial) + Electrical with DIN Plug Optical(dial) + Electrical with Lamp Special	= 0 (standard) = A.. = B.. = D.. = T.. = AD.. = BD.. = DD.. = SP
9b	Maintenance Indicator - cracking pressure	Without 0.8 bar [11.6 psid] 1.5 bar [21.7 psid] 2.5 bar [36.2 psid] 4.2 bar [60.9 psid] 5.0 bar [72.5 psid] 6.0 bar [87.0 psid] 7.0 bar [101.5 psid] Other pressure (in bar)	= - (standard) = ..0.8 = ..1.5 = ..2.5 (std- 40-LD/LDN) = ..4.2 = ..5.0 (std- 160-LD/LDN) = ..6.0 = ..7.0 = as applicable
10	Inlet / Outlet - connections (Refer C1 on pg.5)	BSP Thread (ISO-228) - 1" BSP(F) BSP Thread (ISO-228) - 1-1/4" BSP(F) BSP Thread (ISO-228) - 1-1/2" BSP(F) SAE Flanged - 3000# - SAE 1-1/2" SAE Straight Thread O'Ring Boss (J1926) Special connection With adaptor	= G06 = G07 = G08 = S083 = S** (refer pg.5) = X0 (to be specified) = RA0 (to be specified)
11	Seal Material	Nitrile Viton EPDM Neoprene	= P (standard) = V = E = N
12	Housing Material	Standard - as per catalogue Special	= 0 (Standard) = SP
13	Other Options (multiple options possible)	Without With 1/4" air vent port - duly plugged With 1/4" BSP Air Vent Valve With 1/4" drain port - duly plugged With 1/4" CS drain valve in bowl With 1/4" SS drain valve in bowl	= 0 (standard) = EP = E = 4 = DV = DVX

* Before ordering, check for availability

Ordering Code - Filter Element

2. 0013 - H10XP - A - 0 P - 0 - P
 3 4 5 6ab 11 3

Ordering Code - Seal Kit

D - 160 - LD - 0013 - A - G06 - P - 0
 1 2 3 9a 10 11

Maintenance Indicators

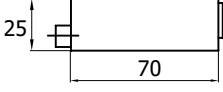
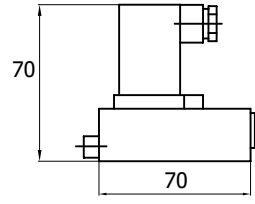
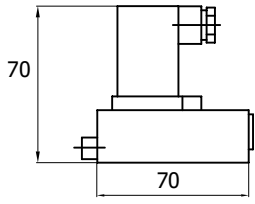
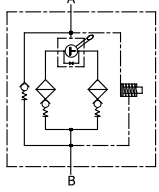
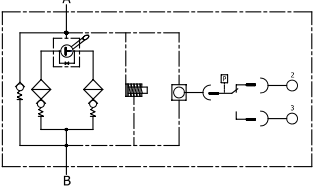
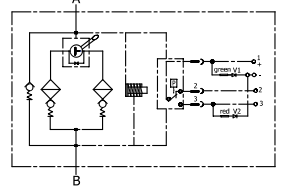
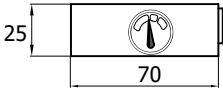
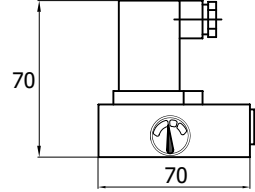
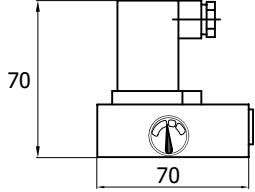
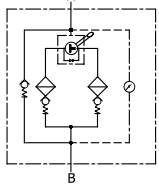
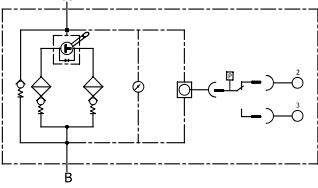
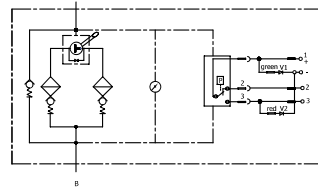
		
A = Optical (Pop-up)	B = Optical (Pop-up) + Electrical	D = Optical (Pop-up) + Electrical with 2 LEDs
Ordering Code F-xx-A0-00-00-P	Ordering Code F-xx-GW-02-00-P	Ordering Code F-xx-GW-26-00-P
		
		
AD = Optical (Dual Dial)	BD = Optical (Dual Dial) + Electrical	DD = Optical (Dual Dial) + Electrical with 2 LEDs
Ordering Code FD-xx-A0-00-00-P	Ordering Code FD-xx-GW-02-00-P	Ordering Code FD-xx-GW-26-00-P
		

Maintenance Indicator functioning

These indicators work on the differential pressure and operate when a preset pressure differential is reached between the inlet & outlet ports.

In the pop-up version a red indicator pin pops out in the housing chamber thereby indicating the state whereas in the dual dial version two dial gauges - with green, yellow & red bands - placed on opposite side indicate the condition. If available, the electronic switching element is also triggered.

In the 2-switching points version (type T) the green LED glows in operating condition, yellow LED glows when 75% of the preset pressure differential is reached and red LED at 100%.

Tightening Torque Values : Nm [ft/lbs] ±10%

Type	Inlet/Outlet Ports		Bowl to head Torque	Mounting Holes	
	Size	Torque		Size	Torque
LD 0003-0013	G 1"	150 [110]	40 [29]	M10 x 1.5	12 [9]
LD 0015-0018	G 1-1/4"	160 [120]	50 [37]	M12 x 1.75	15 [11]
LD 0020-0045	G 1-1/2"	175 [130]	60 [44]	M16 x 2.0	18 [13]
LDN 0040-0100	G 1"	150 [110]	40 [29]	M10 x 1.5	12 [9]
LDN 0160-0250	G 1-1/2"	175 [130]	60 [44]	M16 x 2.0	18 [13]
LDN 0400	SAE1-1/2"		60 [44]	M16 x 2.0	18 [13]

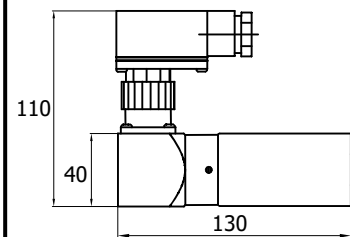

T = Optical/Electrical with 3 LEDs & 2 Switching points

Ordering Code
R-xx-GW-09-Z0-P

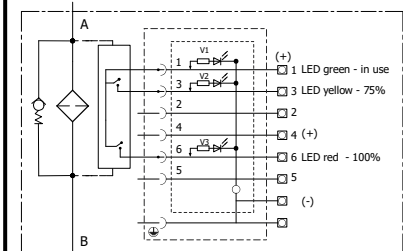

Dimensions

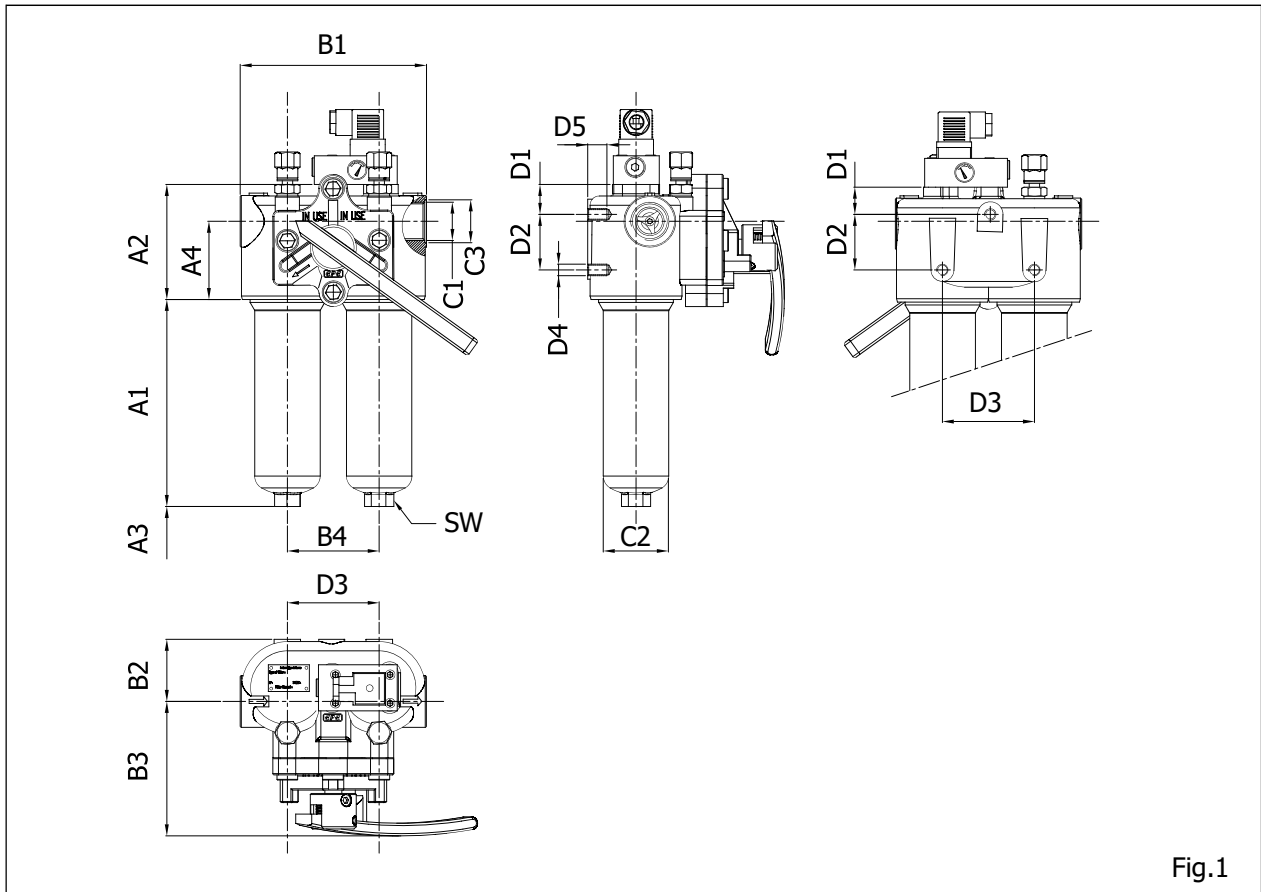

Fig.1

Type	Capacity ltr [gal]	Weight kg [lbs] ¹⁾	A1	A2	A3 ²⁾	A4	B1	B2	B3	B4
40/160 LD 0003	2x0.23 [2x0.06]	6.80 [15.00]	116 [4.57]	102 [4.02]	100 [3.94]	68 [2.67]	162 [6.38]	54 [2.13]	116 [4.57]	80 [3.15]
40/160 LD 0005	2x0.23 [2x0.06]	7.00 [15.43]	116 [4.57]							
40/160 LDN 0040	2x0.23 [2x0.06]	7.00 [15.43]	116 [4.57]							
40/160 LD 0008	2x0.36 [2x0.09]	7.50 [16.53]	180 [7.08]							
40/160 LDN 0063	2x0.36 [2x0.09]	7.50 [16.53]	180 [7.08]							
40/160 LD 0013	2x0.53 [2x0.14]	8.80 [19.40]	270 [10.63]	107 [4.21]	120 [4.72]	67 [2.64]	215 [8.46]	68 [2.68]	118 [4.65]	105 [4.13]
40/160 LDN 0100	2x0.53 [2x0.14]	8.80 [19.40]	270 [10.63]							
40/160 LD 0015	2x0.80 [2x0.21]	13.20 [29.10]	215 [8.46]							
40/160 LD 0018	2x0.99 [2x0.26]	16.30 [35.94]	265 [10.43]	129 [5.08]		84 [3.31]	276 [10.87]	105 [4.13]	110 [4.33]	134 [5.27]
40/160 LD 0020	2x1.19 [2x0.31]	19.00 [41.89]	184 [7.24]							
40/160 LDN 0160	2x1.19 [2x0.31]	19.00 [41.89]	184 [7.24]							
40/160 LD 0030	2x1.76 [2x0.46]	20.00 [44.09]	273 [10.75]							
40/160 LDN 0250	2x1.76 [2x0.46]	20.00 [44.09]	273 [10.75]			84 [3.31]	276 [10.87]	105 [4.13]	110 [4.33]	134 [5.27]
40/160 LD 0045	2x2.72 [2x0.72]	23.00 [50.71]	422 [16.61]							
40/160 LDN 0400	2x2.72 [2x0.72]	23.00 [50.71]	422 [16.61]							

Type	C1 - Conn {Codification}		C2	C3	D1	D2	D3	D4	D5	SW
	BSP/SAE	SAE J1926/1 Thread								
40/160 LD 0003	G1" 20 dp {G06}	1-5/16-12UN 2B {S16} 1-5/8-12UN 2B {S20}	Ø57 [Ø2.24]	-	24 [0.95]	50 [1.97]	80 [3.15]	M10x1.5	15 [0.59]	19 [0.75]
40/160 LD 0005										
40/160 LDN 0040										
40/160 LD 0008										
40/160 LDN 0063										
40/160 LD 0013	G 1 1/4" 30 dp {G07}	1-5/8-12UN 2B {S20} 1-7/8-12UN 2B {S24}	Ø77 [Ø3.03]	-	29 [1.14]	50 [1.97]	105 [4.13]	M12x1.75	17 [0.67]	24 [0.94]
40/160 LDN 0100										
40/160 LD 0015	G 1 1/2" 30 dp {G08}	1-5/8-12UN 2B {S20} 1-7/8-12UN 2B {S24} 2-1/2-12UN 2B {S32}	Ø98 [Ø3.86]	Ø61x1.5dp [Ø2.40]	24 [0.95]	62 [2.44]	134 [5.27]	M16x2.0	20 [0.79]	27 [1.06]
40/160 LD 0020										
40/160 LDN 0160										
40/160 LD 0030										
40/160 LDN 0250	SAE 1-1/2" {S083}									
40/160 LD 0045										
40/160 LDN 0400										

¹⁾ = Weight including standard filter element and maintenance indicator

²⁾ = Servicing height for filter element replacement

Dimensions in mm [inch]

Spare parts list

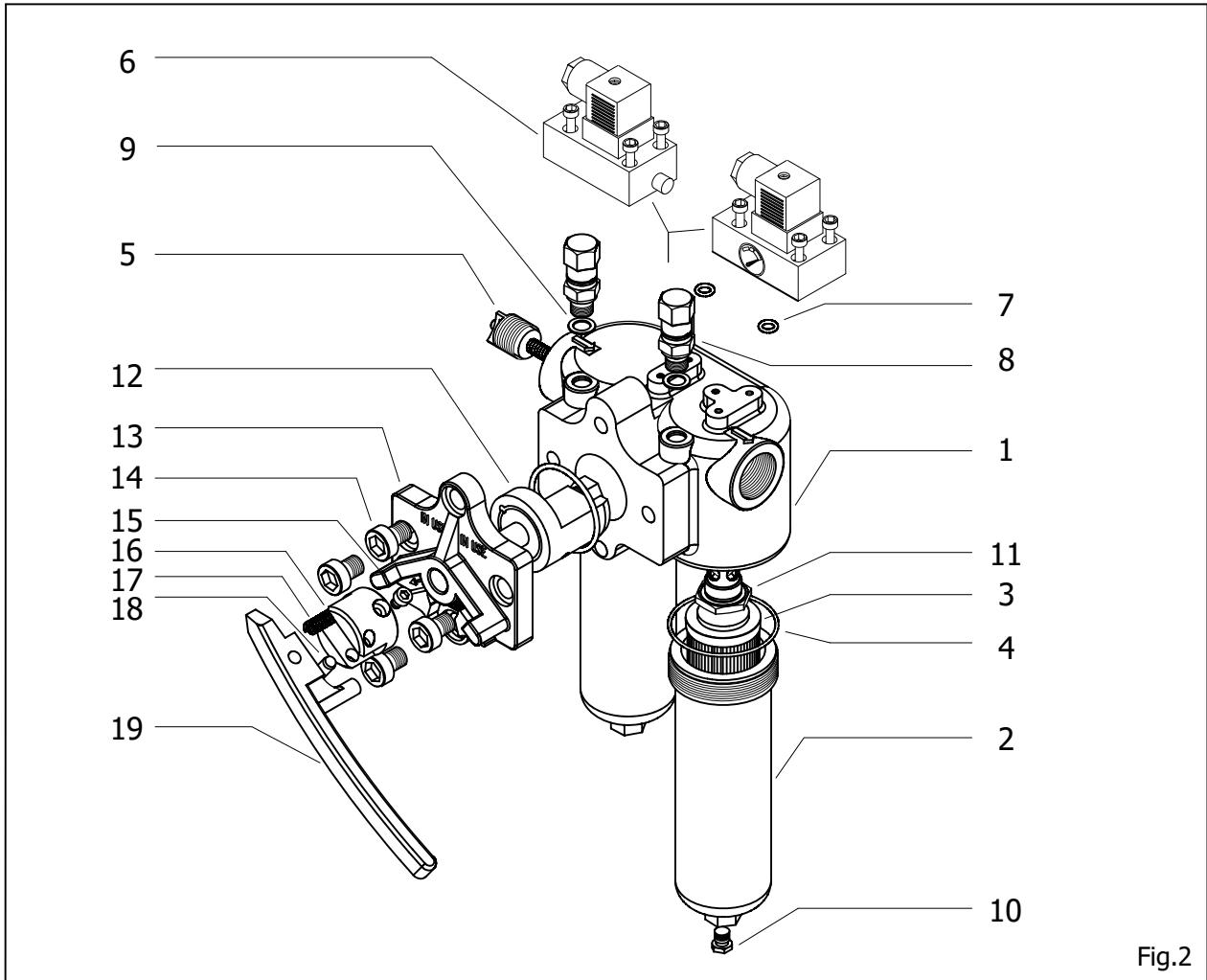

Fig.2

Spare Parts List

Item #	Qty.	Description	Material	0003	0005	0008	0013	0015	0018	0020	0030	0045
					0040	0063	0100		0160	0250	0400	
1	1	Filter Head	GGG50						-			
2	2	Filter Bowl	Carbon steel						-			
3	2	Filter Element	Various	As per "Ordering Code - Filter Element"								
4	2	Housing O-Ring	Buna-N/Viton	Sold as kit - "Ordering Code - Filter Seal Kit"								
5	1	Bypass Valve	Various	Part No.BYP01/xx			Part No.BYP02/xx		Part No.BYP03/xx			
6	1	Maintenance Indicator	Aluminium	As per Section "Maintenance Indicator"								
7	2	Indicator O-Rings	Buna-N/Viton	Sold as kit - "Ordering Code - Filter Seal Kit"								
8	2	Air Vent Plug / Valve	Various	Part No.AVP01/AOO001								
9	2	Seal Ring for air vent	Copper	Sold as kit - "Ordering Code - Filter Seal Kit"								
10	2	Drain Plug	Steel	Part No.DBP01								
11	2	Return Valve Assembly	Various	LMBB79			LMBD79		LMBF79			
12	1	Change-over Valve Body	En8	LMBJ12								
13	1	Flange Cover	GGG50	LMBJ44								
14	4	Hex Socket Head Screw	8.8	H0715X								
15	2	Hex Socket Head Screw	8.8	H0406X								
16	1	Handle Bush	Steel	LMBJ45								
17	1	Spring	Spring Steel	LMBJ18								
18	1	Dowel Pin	Steel	LMBJ43								
19	1	Handle	Al Si 9 Mg	LMBJ35								

Installation

Before installation, conduct a visual check to ensure that the filter has not suffered any damage during shipping / handling. Verify that the requested type matches with what stamped on the nameplate.

Verify operating pressure with name plate information.

During assembly of the filter the tightening torques (refer page 4), the flow direction (direction arrows on the filter head) and the required service height (A3 in fig.1) of the filter element are to be taken into consideration.

Mount the filter assembly using the mounting holes on the filter head (C3) considering the flow direction. Failure to observe flow direction during assembly will cause damage to the filter element and components downstream.

Tighten the mounting bolts to specified torques (page 4).

We recommend using a suitable safety relief valve in the system to ensure the user and equipment are protected against possible damage caused by pressure surges.

Provide for the required servicing clearance below the filter for cleaning / replacing the filter element.

These filters must preferably be installed in vertical position with the filter bowl at the bottom to ensure proper venting and draining.

Proceed to the assembly ensuring the filter is not subjected to any abnormal forces and also fastened to avoid the transmission of vibrations. Tighten the inlet and outlet connections to the specified torques.

Make sure the optical part of the indicator is visible and the electricals connected appropriately.

If the maintenance indicator is ignored the bypass valve, if available, will open when the pressure differential increases thereby bypassing the filter element and contaminated fluid will pass to the clean side of the filter outlet thereby compromising the filtration effectiveness and risking the downstream components.

Connecting electrical indicator

Connect indicator using the three wired cable. Verify electrical ratings on the indicator (6) name plate.

Connection settings:

- | | |
|------------|----------------------------------|
| 1. Closer | 1 (black) + 3 (blue) |
| 2. Opener | 1 (black) + 2 (brown) |
| 3. Changer | 1 (black) + 2 (brown) + 3 (blue) |

Special Instructions

It is strictly forbidden to:

- weld or solder or carry out any mechanical operations on the filter.
- engrave or permanently stamp the surfaces of the filter and / or carry out other operations that could affect or change the mechanical properties of the filter.
- use the filter as a structural element: it should not be subjected to stresses or loads.
- change the data of the nameplate and / or filter without the permission of the manufacturer.
- use a different fluid than those designed for.

Starting Operation

Switch on the service pump.

Bring the change-over handle (19) to the middle position, to fill both housings.

During start-up and filling of the filter ensure that the Filter is properly vented through the vent plugs (8) / vent valve, close when operating fluid appears.

Put desired filter housing in operation position making sure

that the changeover handle is at the extreme depressed position. The pointer on the changeover handle always shows the housing in operation .

Filter is now ready for operation.

Maintenance

The filter element is clogged and must be changed or cleaned when at operating temperature the red pointer on the pop-up indicator (6) is hard against the plastic cap / the pointer on the dual dial indicator (6) is at the end of the red marking and / or the switching process on the electrical indicator is triggered.

Filter element service

Lift the change-over handle (19) to ensure that the second housing (housing not in use) is also filled with fluid or wait for about 15 seconds.

Move the change-over handle (19) from the first housing (henceforth under maintenance) to the second housing (henceforth in use).

Release the change-over handle (19) making sure that the changeover handle is at the extreme depressed position.

Release the pressure of the housing under maintenance by opening the vent plug (8) / vent valve.

Drain the filter housing through the drain plug (10) / drain valve. Unscrew filter bowl (2) and remove filter element (3), turning slightly off from its locator in the filter head (1). Check filter bowl inside and clean if necessary.

Filter element of type H...-XL, H...-XP, H...-XE, H...-XC, AS..., P... and VS ... is to be replaced.

Filter elements with G... and M... media are cleanable. The effectiveness of cleaning depends on the type of dirt and the level of the differential pressure at the time of changing the filter element. If the differential pressure after the filter element's cleaning process exceeds more than 50% of the pre-service value the G... and M... filter element also needs to be replaced.

Remove the safety packing from the new filter element before installing in the filter.

Replace filter element by slightly turning it back on its locator. Check Housing O-Ring (4) on filter bowl (2), replace in case of damage or wear. Screw filter bowl and tighten to the specified torque (page 4) at hexagon bolt using a suitable tool.

Operate filter as described above.

Pressure Directives

Pressure Line Filters for hydraulic application are pressure holding equipment according to Article 2 Section 5 of the Pressure Equipment Directive 2014/68/EU. However, on the basis of the exception in Article 1, Section 2(f) of the PED the pressure line filters are exempt from the PED if they are not classified higher than category I (Guideline A-19) & do not receive any CE mark.

Disposal / Environmental Protection

Careless disposal of the filter, filter element and the residual fluid contained therein can cause environmental pollution.

Dispose the filter / filter element in accordance with provisions applicable in the country of use.

Fluid residues are to be disposed according to the respective safety data sheets valid for the specific hydraulic fluids.

Performance Curves (Flow rate Vs Pressure Drop) - for complete filters

Oil Viscosity : 30 mm²/s [143 SUS]

Specific gravity < 0.9 kg/dm³

Recommended initial Pressure Drop (ΔP) for assembly = 0.8 bar [11.6 psid]

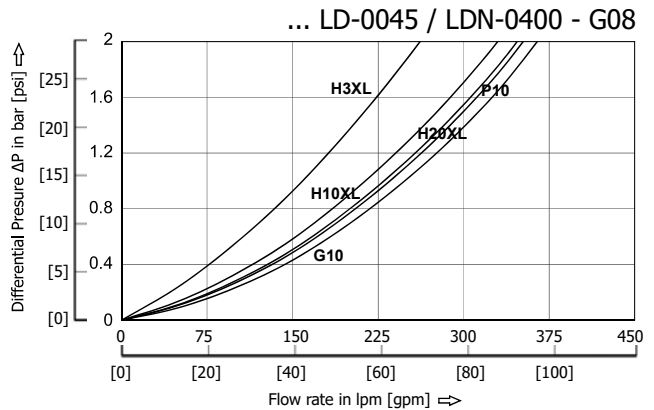
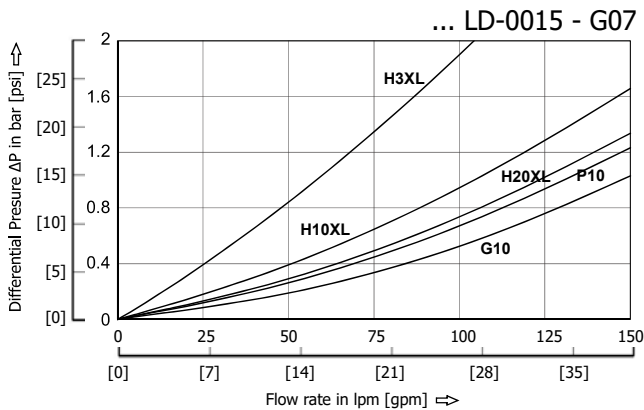
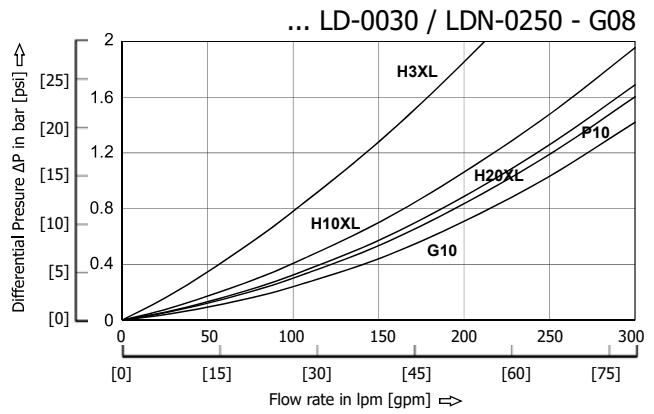
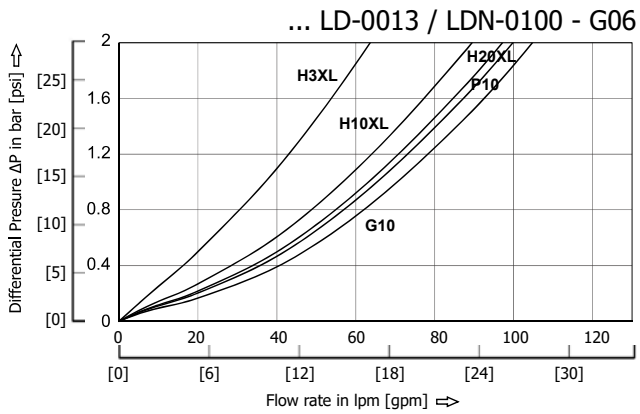
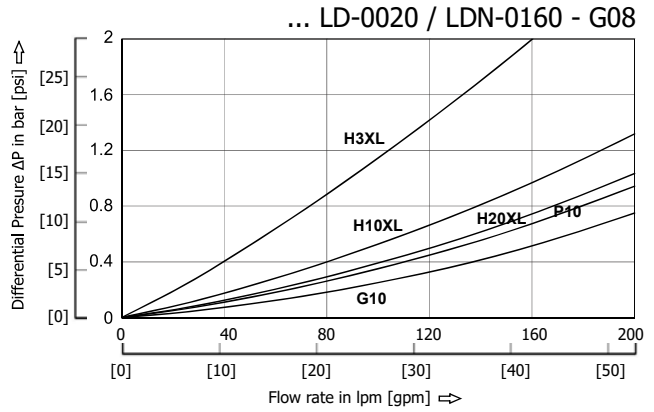
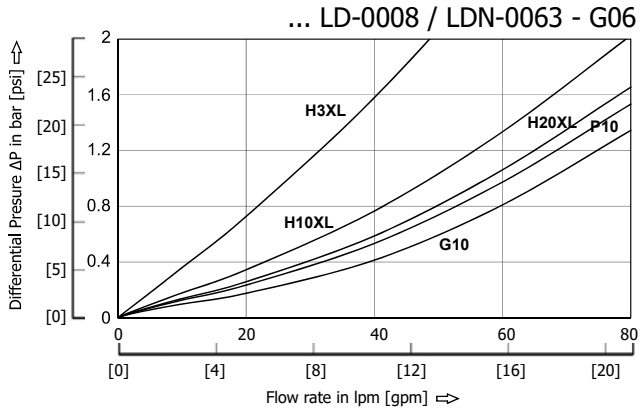
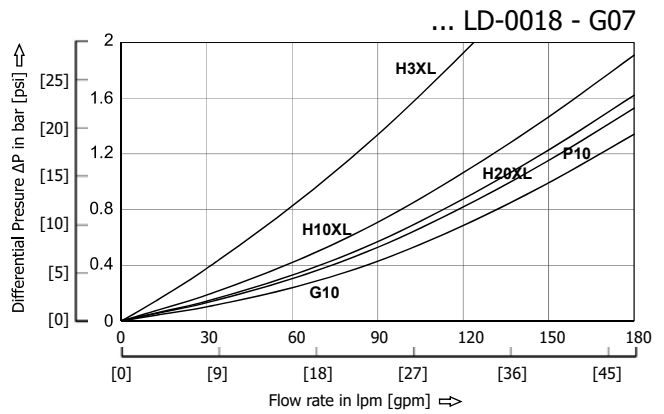
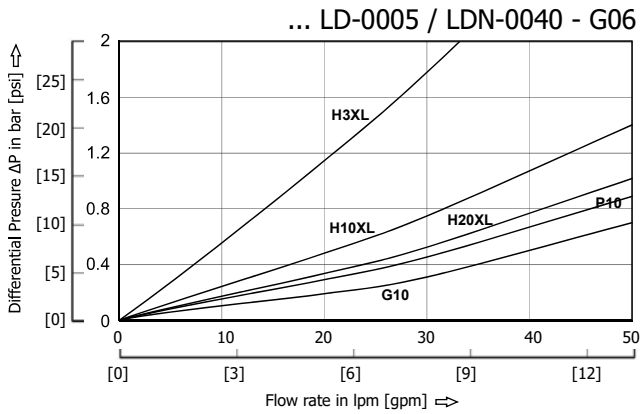

EPE Process Filters & Accumulators Pvt. Ltd., Techni Towers, C-54/A, APIE, Balanagar, Hyderabad - 500 037, Telangana, INDIA
 Ph : +91 40 23778803 | Fax : +91 40 23871447 | business@epe-india.com | www.epe-india.com